

# SRS50-HXA0-K22

SRS/SRM50

MOTOR FEEDBACK SYSTEMS ROTARY HIPERFACE®

**SICK**  
Sensor Intelligence.

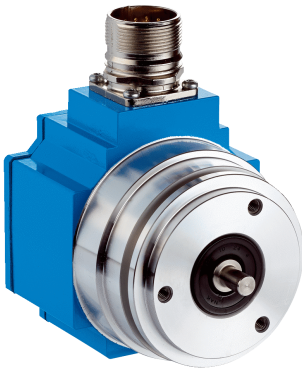

Illustration may differ



### Ordering information

Type	Part no.
SRS50-HXA0-K22	1037100

Other models and accessories → [www.sick.com/SRS\\_SRM50](http://www.sick.com/SRS_SRM50)

### Detailed technical data

#### Performance

<b>Sine/cosine periods per revolution</b>	1,024
<b>Number of the absolute ascertainable revolutions</b>	1
<b>Total number of steps</b>	32,768
<b>Measuring step</b>	0.3 " For interpolation of the sine/cosine signals with, e. g., 12 bits
<b>Integral non-linearity</b>	Typ. ± 45 ", Error limits for evaluating sine/cosine period
<b>Differential non-linearity</b>	± 7 ", Non-linearity within a sine/cosine period
<b>Operating speed</b>	≤ 6,000 min <sup>-1</sup> , up to which the absolute position can be reliably produced
<b>Available memory area</b>	1,792 Byte

#### Interfaces

<b>Type of code for the absolute value</b>	Binary
<b>Code sequence</b>	Increasing, when turning the shaft For clockwise rotation, looking in direction "A" (see dimensional drawing), For clockwise shaft rotation, looking in direction "A" (see dimensional drawing)
<b>Communication interface</b>	HIPERFACE®

#### Electrical data

<b>Connection type</b>	Male connector, M23, 12-pin, radial
<b>Supply voltage</b>	7 V DC ... 12 V DC
<b>Recommended supply voltage</b>	8 V DC
<b>Power consumption</b>	80 mA <sup>1)</sup>
<b>Output frequency for sine/cosine signals</b>	≤ 200 kHz

<sup>1)</sup> Without load.

#### Mechanical data

<b>Shaft version</b>	Solid shaft
<b>Shaft diameter</b>	6 mm
<b>Flange type / stator coupling</b>	Servo flange, stator coupling

<b>Dimensions</b>	See dimensional drawing
<b>Weight</b>	≤ 0.2 kg
<b>Moment of inertia of the rotor</b>	25 gcm <sup>2</sup>
<b>Operating speed</b>	≤ 12,000 min <sup>-1</sup>
<b>Angular acceleration</b>	≤ 200,000 rad/s <sup>2</sup>
<b>Operating torque</b>	1 Ncm
<b>Start up torque</b>	+ 1.5 Ncm
<b>Permissible movement of the drive element, static</b>	± 0.3 mm
<b>Permissible movement of the drive element, dynamic</b>	± 0.1 mm
<b>Permissible Load capacity of shaft</b>	40 N (radial) 20 N (axial)
<b>Life of ball bearings</b>	3.6 x 10 <sup>9</sup> revolutions

### Ambient data

<b>Operating temperature range</b>	-30 °C ... +85 °C
<b>Storage temperature range</b>	-30 °C ... +90 °C, without package
<b>Relative humidity/condensation</b>	90 %, Condensation not permitted
<b>Resistance to shocks</b>	100 g, 10 ms, 10 ms (according to EN 60068-2-27)
<b>Frequency range of resistance to vibrations</b>	20 g, 10 Hz ... 2,000 Hz (according to EN 60068-2-6)
<b>EMC</b>	According to EN 61000-6-2 and EN 61000-6-3 <sup>1)</sup>
<b>Enclosure rating</b>	IP65, with mating connector inserted (according to IEC 60529)

<sup>1)</sup> The EMC according to the standards quoted is achieved when the motor feedback system is mounted in an electrically conductive housing, which is connected to the central earthing point of the motor controller via a cable screen. The GND-(0 V) connection of the supply voltage is also grounded here. If other shielding concepts are used, users must perform their own tests.

### Classifications

<b>ECl@ss 5.0</b>	27270590
<b>ECl@ss 5.1.4</b>	27270590
<b>ECl@ss 6.0</b>	27270590
<b>ECl@ss 6.2</b>	27270590
<b>ECl@ss 7.0</b>	27270590
<b>ECl@ss 8.0</b>	27270590
<b>ECl@ss 8.1</b>	27270590
<b>ECl@ss 9.0</b>	27270590
<b>ECl@ss 10.0</b>	27273805
<b>ECl@ss 11.0</b>	27273901
<b>ETIM 5.0</b>	EC001486
<b>ETIM 6.0</b>	EC001486
<b>ETIM 7.0</b>	EC001486
<b>UNSPSC 16.0901</b>	41112113

**Dimensional drawing** (Dimensions in mm (inch))

General tolerances according to DIN ISO 2768-mk

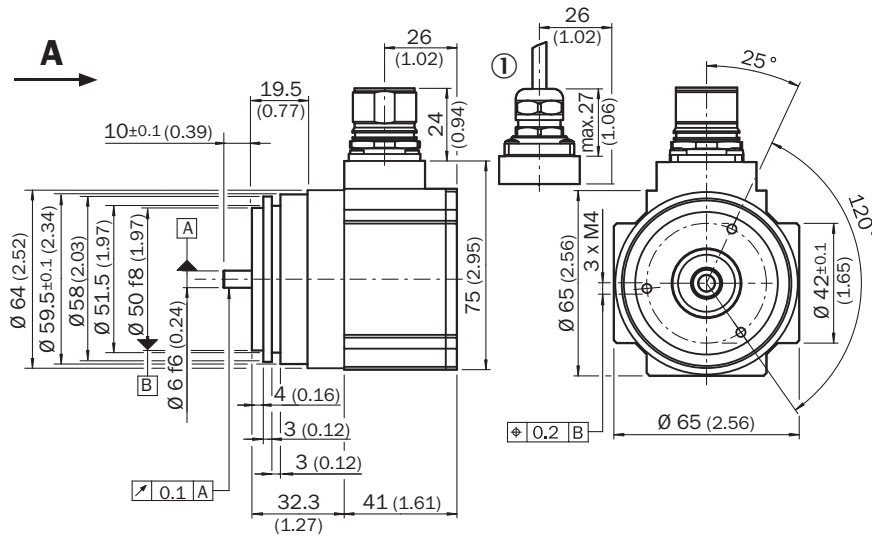

① R = min. bending radius 40 mm

**PIN assignment**

View of the M23 male connector plug-in face

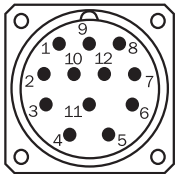

PIN	Signal	Colour of Wires	Explanation
1	REFCOS	black	Process data channel
2	Data +	grey or yellow	RS-485-parameter channel
3	N. C.	-	N. C.
4	N. C.	-	N. C.
5	SIN	white	Process data channel
6	REFSIN	brown	Process data channel
7	Data -	green or purple	RS-485-parameter channel
8	COS	pink	Process data channel
9	N. C.	-	N. C.
10	GND	blue	Ground connection
11	N. C.	-	N. C.
12	Us	red	7 ... 12 V Supply voltage

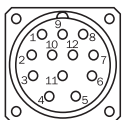

View of the plug-in face

Screen connection on connector housing

N. C. = Not connected

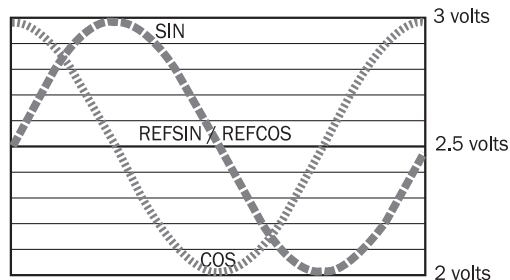

## Diagrams

Signal diagram for clockwise rotation of the shaft looking in direction "A" (see dimensional drawing) 1 period = 360 ° : 1024



## Recommended accessories

Other models and accessories → [www.sick.com/SRS\\_SRM50](http://www.sick.com/SRS_SRM50)

	Brief description	Type	Part no.
<b>Plug connectors and cables</b>			
	Head A: cable Head B: Flying leads Cable: HIPERFACE®, HIPERFACE®, PUR, halogen-free, shielded	LTG-2708-MW	6028361
	Head A: female connector, M23, 12-pin, straight Head B: Flying leads Cable: HIPERFACE®, PUR, halogen-free, shielded, 3 m	DOL-2308-G03MJB2	2031070
	Head A: female connector, M23, 12-pin, straight Head B: Flying leads Cable: HIPERFACE®, PUR, halogen-free, shielded, 5 m	DOL-2308-G05MJB2	2031071
	Head A: female connector, M23, 12-pin, straight Head B: Flying leads Cable: HIPERFACE®, PUR, halogen-free, shielded, 10 m	DOL-2308-G10MJB2	2031072
	Head A: female connector, M23, 12-pin, straight Head B: Flying leads Cable: HIPERFACE®, PUR, halogen-free, shielded, 15 m	DOL-2308-G15MJB2	2031073
	Head A: female connector, M23, 12-pin, straight Head B: Flying leads Cable: HIPERFACE®, PUR, halogen-free, shielded, 1.5 m	DOL-2308-G1M5JB2	2031069
<b>Programming and configuration tools</b>			
	SVip® LAN programming tool for all motor feedback systems	PGT-11-S LAN	1057324
	SVip® WLAN programming tool for all motor feedback systems	PGT-11-S WLAN	1067474

## SICK AT A GLANCE

SICK is one of the leading manufacturers of intelligent sensors and sensor solutions for industrial applications. A unique range of products and services creates the perfect basis for controlling processes securely and efficiently, protecting individuals from accidents and preventing damage to the environment.

We have extensive experience in a wide range of industries and understand their processes and requirements. With intelligent sensors, we can deliver exactly what our customers need. In application centers in Europe, Asia and North America, system solutions are tested and optimized in accordance with customer specifications. All this makes us a reliable supplier and development partner.

Comprehensive services complete our offering: SICK LifeTime Services provide support throughout the machine life cycle and ensure safety and productivity.

For us, that is “Sensor Intelligence.”

## WORLDWIDE PRESENCE:

Contacts and other locations –[www.sick.com](http://www.sick.com)